

AMERICAN CHAMPION AIRCRAFT CORPORATION  
ROCHESTER, WI 53167

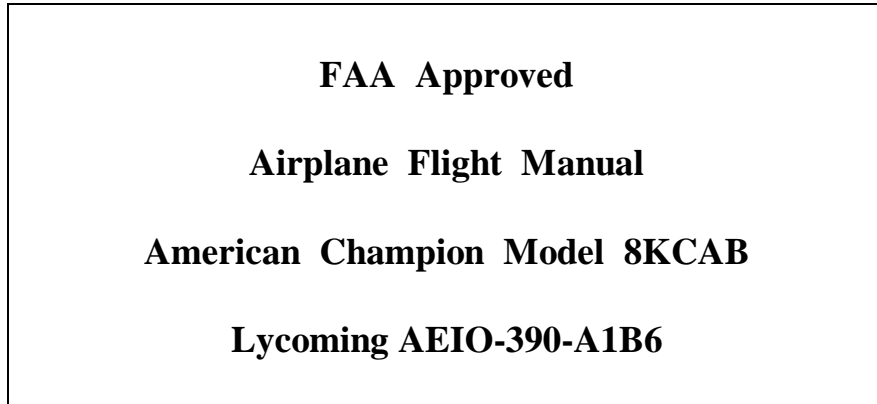

This flight manual applies to 8KCAB aircraft beginning with serial number 1116-2012 and up equipped with a Lycoming AEIO-390-A1B6 engine, MTV-15-B-C/C193-25 propeller and 4-2139 aluminum gear legs.

REGISTRATION NUMBER: \_\_\_\_\_  
SERIAL NUMBER: \_\_\_\_\_

**THIS MANUAL IS PART OF THE REQUIRED EQUIPMENT  
AND MUST REMAIN IN THE AIRPLANE AT ALL TIMES.**

This AFM distinguishes FAA approved data from unapproved data by noting “FAA APPROVED” in the upper right hand corner of each page containing such FAA approved data. Additional information is provided by American Champion Aircraft Corporation and is included as unapproved sections of the manual.

APPROVED: \_\_\_\_\_  
For: Timothy Smyth  
Manager, Chicago Aircraft Certification Office

Date: \_\_\_\_\_

Record of Revisions

Revision	By	Description	Date	Pages Affected
New	JJB	Original Issue	12-1-2012	All
A	JJB	Was ICAO Annex 16, Vol. I, App. 6	6-17-2013	1 and 19

## Table of Contents

1.0	Operating Limitations.....	4
1.1	Airspeed Limitations .....	4
1.2	Airspeed Indicator Markings .....	4
1.3	Powerplant Limitations.....	5
1.4	Powerplant Instrument Markings.....	5
1.5	Miscellaneous Instrument Markings.....	5
1.6	Weight Limits.....	5
1.7	Center of Gravity Limits.....	6
1.8	Maneuver Limits .....	6
1.9	Flight Load Factor Limits .....	7
1.10	Kinds of Operation .....	8
1.11	Fuel Limitations .....	8
1.12	Outside Air Temperature Limits .....	8
1.13	Types of Surface .....	8
1.14	Required Placards.....	8
2.0	Emergency Procedures.....	10
2.1	Emergency Airspeeds .....	10
2.2	Engine Failure During Takeoff Roll .....	10
2.3	Engine Failure Immediately After Takeoff .....	10
2.4	Engine Failure During Flight (Restart Procedure) .....	10
2.5	Precautionary Landing With Power .....	10
2.6	Forced Landing without Engine Power.....	11
2.7	Engine Fire - Start .....	11
2.8	Engine Fire - Ground.....	11
2.9	Engine Fire - In Flight .....	11
2.10	Electrical System Malfunction .....	12
2.11	Electrical System Fire.....	12
2.12	Emergency Exits .....	12
2.13	Loss of Governor Control .....	12
2.14	Fuel Pressure Loss .....	12
2.15	Spin Recovery .....	12
3.0	Normal Procedures .....	13
3.1	Pre-Flight Check (See Page 14).....	13
3.2	Pre-Start Check.....	14
3.3	Engine Start .....	15
3.4	Cockpit (Before Flight) .....	16
3.5	Engine Run-Up .....	16
3.6	Takeoff (Normal) .....	16
3.7	Takeoff (Short Field).....	16
3.8	Climb .....	16
3.9	Cruise .....	17
3.10	Landing (Normal).....	17
3.11	Landing (Short Field) .....	17

3.12	Balked Landing .....	17
3.13	After Landing .....	17
3.14	Shut Down and Securing Aircraft .....	18
3.15	Alternate Air .....	18
3.16	Fuel Pump .....	18
3.17	Detuning .....	18
3.18	Acrobatic Operation .....	18
3.19	Spins .....	19
3.20	Maximum Demonstrated Crosswind .....	19
3.21	Turbulence Penetration Speed .....	19
3.22	Noise Characteristics .....	19
4.0	Performance Information .....	20
4.1	Airspeed Calibration .....	20
4.2	Stalling Speeds .....	20
4.3	Best Glide Speed and Distance .....	20
4.4	Climb Rate and Gradients .....	21
4.5	Takeoff Distance .....	21
4.6	Time, Fuel, and Distance to Climb .....	22
4.7	Cruise Performance .....	23
4.8	Landing Distance .....	24
5.0	Loading Information .....	25
5.1	Weight and Balance .....	25
5.2	Moment and Loading .....	25
5.3	Equipment .....	25
5.4	Equipment List .....	28

## 1.0 Operating Limitations

This section contains operating limitations, instrument markings, and placards necessary for the safe operation of the airplane. The Federal Aviation Administration has approved the operating limitations section. Observance of these operation limitations is required by Federal Aviation Regulations.

### 1.1 Airspeed Limitations

Speed	CAS (mph)	IAS (mph)	Remarks
Never Exceed $V_{NE}$	200	207	Do not exceed this speed in any operation
Maximum Structural Cruising $V_{NO}$	160	162	Do not exceed this speed except in smooth air and then only with caution
Normal Category Maneuvering $V_A$	110	110	(1950lb) Do not make full or abrupt control movements above this speed
Acrobatic Category Maneuvering $V_A$	134	135	(1800lb) Do not make full or abrupt control movements above this speed

### 1.2 Airspeed Indicator Markings

Marking	Value or Range (mph)	Significance
Green Arc	58-160	Normal operating range, extends from power-off stall speed ( $V_{S1}$ ) to maximum structural cruising speed ( $V_{NO}$ )
Yellow Arc	160-200	Operate with caution and only in smooth air, extends from maximum structural cruising speed ( $V_{NO}$ ) to never exceed speed ( $V_{NE}$ )
Red Radial Line	200	Maximum speed for all operations, never exceed speed ( $V_{NE}$ )

### 1.3 Powerplant Limitations

Engine	Lycoming AEIO-390-A1B6
Engine Operating Limits	2700 rpm (210 hp) for all operations
Oil Pressure	Minimum 25 psi, Maximum 100 psi
Fuel Pressure	Minimum 14 psi, Maximum 45 psi
Propeller	MT Propeller MTV-15-B-C/C193-25 Diameter: 75.75 to 76.25 in
Fuel Grades	100 (Green) or 100LL (Blue)
Oil Grades	Lycoming SI-1014

### 1.4 Powerplant Instrument Markings

Tachometer	Green Arc Red Radial	500-2700 rpm 2700 rpm
Manifold Pressure	Red Radial	29 in-Hg
Cylinder Head Temperature	Green Arc Red Radial	200°-465° F 465° F
Oil Temperature	Green Arc Red Radial	100°-235° F or 120°-235° F 235° F
Oil Pressure	Green Arc Yellow Arc Red Radial	60-100 psi 25-60 psi 25 psi, 100 psi
Fuel Pressure	Green Arc Red Radial	14-45 psi 14 psi, 45 psi

### 1.5 Miscellaneous Instrument Markings

Accelerometer	Green Arc Yellow Arc Red Radial	-1.52 to 3.8 g -5.0 to -1.52 g, 3.8 to 6.0 g -5.0 g, 6.0 g
Vacuum Gauge	Green Arc Red Radial	3.5 to 5.0 in-Hg 3.5 in-Hg, 5.0 in-Hg
Fuel Quantity	Red Radial	E (1.5 Gallon Each Tank)

### 1.6 Weight Limits

#### Normal Category

Gross Weight	1950 lb
Maximum Baggage	100 lb (71.0 in aft of datum)

#### Acrobatic Category

Gross Weight	1800 lb
Maximum Baggage	Baggage Prohibited

## 1.7 Center of Gravity Limits

### Normal Category

Center of Gravity Range	+14.7 in to +18.5 in at 1950 lb +11.5 in to +18.5 in at 1550 lb or less Straight line variation between points given
Reference Datum	Wing Leading Edge

### Acrobatic Category

Center of Gravity Range	+13.5 in to +18.5 in at 1800 lb +11.5 in to +18.5 in at 1550 lb or less Straight line variation between points given
Reference Datum	Wing Leading Edge

## 1.8 Maneuver Limits



### Normal Category Maneuvers



No acrobatic maneuvers, including spins, are authorized.

### Acrobatic Category Maneuvers

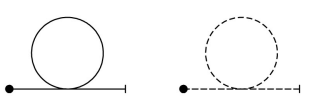
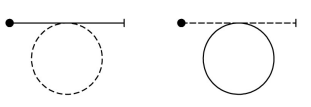
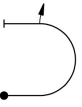
The following maneuvers are approved. Variations and combinations of the maneuvers are also approved, provided that the speed and load factor limitations are not exceeded. Tailslides and lomcevak's are not approved.

Proper use and application of controls and maneuvering load factors are essential to speed control. Improper and/or inadequate application of maneuvering load factors may result in rapid acceleration resulting in unsafe flight situations.

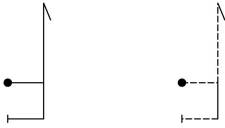
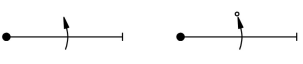
Maneuver	Aresti Symbol	Entry Speed IAS (mph)	Remarks
Loop - Up		140	Enter Full Power, Pull or Push: $\pm 4$ G Speed at Top: 50 MPH Exit Pull or Push: $\pm 4$ G Speed at Exit: 140 MPH
Loop - Down		70	Enter 70 MPH or Slower, Power Off Pull or Push: $\pm 4$ G Speed at Bottom: 150 MPH Full Power, Pull or Push: $\pm 4$ G Exit 50 MPH
Immelman		145	Enter Full Power, Pull: +4 G Exit 50 MPH
English Bunt		70	Enter 70 MPH or Slower, Power Off Push: -4 G Exit 150 MPH

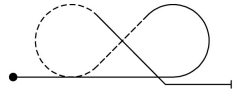
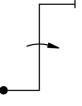
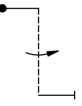
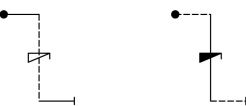
Maneuver	Aresti Symbol	Entry Speed IAS (mph)	Remarks
Hammerhead		140	Enter Full Power, Pull or Push: $\pm 4$ G Speed at Turn: 40 MPH Pull or Push: $\pm 4$ G Exit 140 MPH
Slow or Barrel Roll		130	Use Smooth Application of Controls No Full or Abrupt Control Movements Above Maneuvering Speed ( $V_A$ )
Snap Roll		90	Enter 90 MPH or Slower, Full Power Exit: 90 MPH
Inside - Outside Eight		140	Enter Full Power, Pull: +4 G Begin Outside Eight 140 MPH Push: -4 G Exit 140 MPH
Vertical Roll - Up		180	Enter Pull: + 4 G to Vertical Up Push: -2 G to Level Upright Exit 50 MPH
Vertical Roll - Down		60	Enter 60 MPH or Slower, Power - Idle Push: -2 G to Vertical Down Pull: 4 G to Level Upright Exit 150 MPH
Spin - Upright or Inverted		Stall	Recover with Full Opposite Rudder and Positive Movement of the Stick to Neutral Until Rotation Stops - Then Neutralize Rudder and Smoothly Recover from Dive to Level Flight. Free Release of Controls is <u>NOT</u> Adequate for Spin Recovery; Positive Movement of Controls is Required.

## 1.9 Flight Load Factor Limits

The limit load factors are not to be exceeded during any flight condition.

### Normal Category

The Normal Category limit load factors are +3.8g and -1.52g. Normal Category limit load factors are indicated by the ends of the green arc on the accelerometer.

### Acrobatic Category

The Acrobatic Category limit load factors are +6.0g and -5.0g. Acrobatic Category limit load factors are indicated by the red radial lines on the accelerometer. Load factors within the yellow arc are permitted in the Acrobatic Category only. The accelerometer is required for Acrobatic Category operations.

## 1.10 Kinds of Operation

Only VFR, day or night, operation is approved. Equipment listed in the Aircraft Equipment List as "R" is required to be installed and operational for VFR day or night flight. Flight into known icing conditions is prohibited.

## 1.11 Fuel Limitations

Left and Right Wing Tanks

Total Fuel: 43.0 Gallons; 21.5 Gallons per tank  
Useable Fuel: 40.0 Gallons; 20.0 Gallons per tank  
Unusable Fuel: 3.0 Gallons; 1.5 Gallons per tank

A header tank provides fuel for 2.0 minutes of inverted flight. One minute of positive G flight is required to completely refill the header tank.

## 1.12 Outside Air Temperature Limits

Adequate powerplant cooling has been demonstrated for outside air temperatures below 120°F. Remove oil cooler covers when outside air temperature exceeds 40°F.

## 1.13 Types of Surface

Operations may be conducted from hard surface, grass, gravel, or similar surfaces. Performance allowances shall be made in accordance with Sections 4.5 and 4.8.

## 1.14 Required Placards

### In Full View of Pilot

"MANEUVERING SPEED 110 MPH (96 KNOTS) CAS  
DEMONSTRATED CROSSWIND VELOCITY 20 MPH (17 KNOTS)"

"SOLO FROM FRONT SEAT ONLY. NO ACROBATIC MANEUVERS, INCLUDING SPINS, APPROVED IN NORMAL CATEGORY. DAY OR NIGHT VFR OPERATION ONLY. FLIGHT IN KNOWN ICING PROHIBITED. TO RECOVER FROM NORMAL OR INVERTED SPIN, USE FULL OPPOSITE RUDDER AND NEUTRALIZE ELEVATOR."

"THIS AIRPLANE MUST BE OPERATED AS A NORMAL OR ACROBATIC CATEGORY AIRPLANE IN COMPLIANCE WITH THE OPERATING LIMITATIONS STATED IN THE FORM OF PLACARDS, MARKINGS AND MANUALS. MARKINGS AND PLACARDS (EXCEPT ACCELEROMETER MARKINGS) REFER TO NORMAL CATEGORY ONLY. SEE AIRPLANE FLIGHT MANUAL FOR ACROBATIC CATEGORY INFORMATION, WEIGHT AND BALANCE INFORMATION AND OTHER OPERATING LIMITATIONS."

"NO SMOKING"

"MAGNETIC COMPASS MAY DEVIATE AS MUCH AS 30° WITH PITOT HEAT ON" (Heated Pitot)

"SEAT BACK RESTRAINER CABLE MUST BE CONNECTED BEFORE FLIGHT UNLESS CONTROL STICK IS REMOVED"



**In Baggage Compartment**

“MAXIMUM BAGGAGE 100 LBS”

**On Forward Left Side Window**

“DO NOT OPEN ABOVE 130 MPH”

“ALTERNATE EMERGENCY EXIT, UNLATCH - FORCE FORWARD PORTION PAST STOP”

**On Emergency Door Release**

“EMERGENCY DOOR RELEASE, PULL PIN - PULL HANDLE”

**Adjacent to Fuel Gauge**

“FUEL IN TANK WHEN GAUGE READS ‘E’ (EMPTY) CANNOT BE SAFELY USED IN FLIGHT”

**Above Fuel Shutoff Rod**

“FUEL 40 GAL USEABLE - DOWN ON”

**Adjacent to Fuel Cap**

“AVGAS 100 OCTANE 20 GALLONS”

**Adjacent to Strobe Light Switch**

“TURN OFF STROBE LIGHTS WHEN TAXIING IN VICINITY OF OTHER AIRCRAFT OR DURING FLIGHT THROUGH CLOUD, FOG, OR HAZE. STANDARD POSITION LIGHTS TO BE ON FOR ALL NIGHT OPERATIONS.”

**On Front Seat Rear Leg**

“REAR SEAT P/N 7-1500 OR 7-1501 AND REAR CONTROL STICK P/N 4-1711 REQ'D WITH THIS SEAT INSTALLATION” (Adjustable Front Seat)

**On Rear Control Stick**

“REAR STICK P/N 4-1711” (Adjustable Front Seat)

**On Rear Seat Front Leg**

“REAR SEAT P/N 7-1500” or “REAR SEAT P/N 7-1501” (Adjustable Front Seat)

## 2.0 Emergency Procedures

### 2.1 Emergency Airspeeds

Engine Failure After Takeoff.....	76 mph IAS
Best Glide (1950lb).....	70 mph IAS
(1800lb).....	68 mph IAS
(1650lb).....	65 mph IAS
Precautionary Landing with Engine Power .....	76 mph IAS
Forced Landing without Engine Power .....	76 mph IAS

### 2.2 Engine Failure During Takeoff Roll

- 1) Throttle - idle
- 2) Brakes - apply
- 3) Mixture - idle cut-off
- 4) Ignition switches - off
- 5) Master switch - off

### 2.3 Engine Failure Immediately After Takeoff

If possible land on remaining runway or land ahead. Do not attempt to reverse course.

- 1) Airspeed - 76 mph IAS
- 2) Mixture - idle cut-off
- 3) Fuel valve - off
- 4) Ignition switches - off
- 5) Master switch - off

### 2.4 Engine Failure During Flight (Restart Procedure)

- 1) Airspeed - 80 mph IAS
- 2) Throttle - 1/2 travel
- 3) Alternate air - on
- 4) Mixture - rich
- 5) Propeller - full forward
- 6) Fuel valve - on
- 7) Master - on
- 8) Fuel pump - on
- 9) Ignition switches - on
- 10) Starter - engage (if propeller is stopped)

### 2.5 Precautionary Landing With Power

- 1) Speed - 76 mph IAS
- 2) Master switch - off
- 3) Door - unlatch prior to touchdown
- 4) Touchdown - tail low

## 2.6 Forced Landing without Engine Power

- 1) Speed - 76 mph IAS
- 2) Mixture - idle cut-off
- 3) Fuel pump - off
- 4) Fuel valve - off
- 5) Ignition switches - off
- 6) Master switch - off
- 7) Door - unlatch prior to touchdown
- 8) Touchdown - tail low

## 2.7 Engine Fire - Start

- 1) Starter - continue cranking

If engine starts:

- 2) Throttle - 2100 rpm for 1 to 2 minutes
- 3) Engine - Shutdown and inspect for damage

If engine fails to start:

- 2) Mixture - idle cut-off
- 3) Throttle - full open
- 4) Fuel valve - off
- 5) Ignition switches - off
- 6) Master switch - off
- 7) Exit aircraft
- 8) Fire extinguisher - apply as necessary
- 9) Fire damage - inspect and repair prior to flight

## 2.8 Engine Fire - Ground

- 1) Mixture - idle cut-off
- 2) Fuel valve - off
- 3) Ignition switches - off
- 4) Master switch - off
- 5) Exit aircraft
- 6) Fire extinguisher - apply as necessary
- 7) Fire damage - inspect and repair prior to flight

## 2.9 Engine Fire - In Flight

- 1) Mixture - idle cut-off
- 2) Fuel valve - off
- 3) Ignition switches - off
- 4) Master switch - off
- 5) Cabin heaters - off
- 6) Airspeed - 100 mph IAS or greater
- 7) Accomplish emergency landing and exit aircraft

## 2.10 Electrical System Malfunction

The ammeter indicates current to or from the battery. A steady discharge on the ammeter indicates an inoperative alternator system.

- 1) Master Switch - cycle to reset the over voltage relay
- 2) If excessive battery discharge continues, turn off all nonessential electrical equipment to conserve battery power.
- 3) Land as soon as practical as the battery will furnish electrical power for a limited time only.

## 2.11 Electrical System Fire

An electrical fire is usually indicated by an odor of hot or burning insulation and wisps of smoke. Should an electrical fire develop, the following procedures are recommended.

- 1) Master switch - off
- 2) Electrical switches - off, leave magneto switches on
- 3) Vents, windows, cabin heaters - closed, open only if necessary for ventilation
- 4) If fire continues, land as soon as practical.

If fire/smoke stops and electrical power is required for the remainder of the flight, turn the master switch on, followed by the desired circuit switch. Allow one minute between turning on each switch in order that the faulty circuit may be located and switched off.

## 2.12 Emergency Exits

The right cabin door serves as the primary exit. The door may be removed by releasing the upper window latches, removing the safety pin, and pulling the red emergency door release handle. Push the door away from the aircraft if necessary. Exit may also be made from left side of aircraft by opening left window. Force forward portion of window past the stop by pushing out on the forward window frame.

## 2.13 Loss of Governor Control

In the event governor failure or oil pressure loss, the propeller will automatically go to the coarse pitch, low RPM position. Use throttle as necessary to execute a precautionary landing.

## 2.14 Fuel Pressure Loss

In the event of fuel pressure loss or fluctuation, turn "ON" the fuel pump.

## 2.15 Spin Recovery

Normal Category spins are not approved. If a spin is inadvertently entered, initiate recovery immediately. Refer to Section 3.19 for spin recovery.

### 3.0 Normal Procedures

#### 3.1 Pre-Flight Check (See Page 14)

- 1)
  - a. Release controls.
  - b. Check ignition switches "OFF".
  - c. Check fuel quantity on fuel gauges.
  - d. Fuel valve "ON".
  - e. Inspect seat belts for condition.
  - f. Secure rear seat belt, rear shoulder harness, and all loose or hanging objects if not in use. Determine that the rear seat folding back has two restrainer cables to prevent seat back from folding forward and interfering with rear stick movement.
  - g. Emergency locator transmitter - armed.
  
- 2)
  - a. Check right wing root cover for security.
  - b. Check aileron for freedom of movement and security.
  - c. Check wing and struts for general condition.
  
- 3)
  - a. Check right main wheel for condition and proper inflation.
  - b. Visually check right fuel quantity and filler cap security.
  
- 4)
  - a. Check oil level and secure dip stick. Inspect engine compartment for general condition, fuel leaks, oil leaks, etc.
  - b. Check that the cowl doors are properly latched.
  - c. On first flight of day and after refueling, drain fuel from gascolator.
  - d. Check windshield for cleanness.
  - e. Check prop for condition and prop spinner for security.
  - f. Check prop blade shank for excessive grease leakage.
  - g. Check air filter for cleanliness and security.
  
- 5)
  - a. Check left main wheel for condition and proper inflation.
  - b. Visually check left fuel quantity and filler cap security.
  - c. Check fuel vent for stoppage.
  - d. Check pitot tube for stoppage.
  - e. Inspect stall warning vane for freedom of movement.
  
- 6)
  - a. Check wing root cover for security.
  - b. Check aileron for freedom of movement and security.
  - c. Check wing and struts for general condition.

- 7) a. On first flight of day and after refueling, drain fuel from aft fuselage drain.  
b. Inspect bottom of aircraft for general condition.  
c. Inspect left static port for stoppage.
  
- 8) a. Check tail surfaces and brace wires for general condition.  
b. Check control surfaces and trim tab for freedom of movement and security.  
c. Check tail wheel security and proper inflation.  
d. Inspect right static port for stoppage.

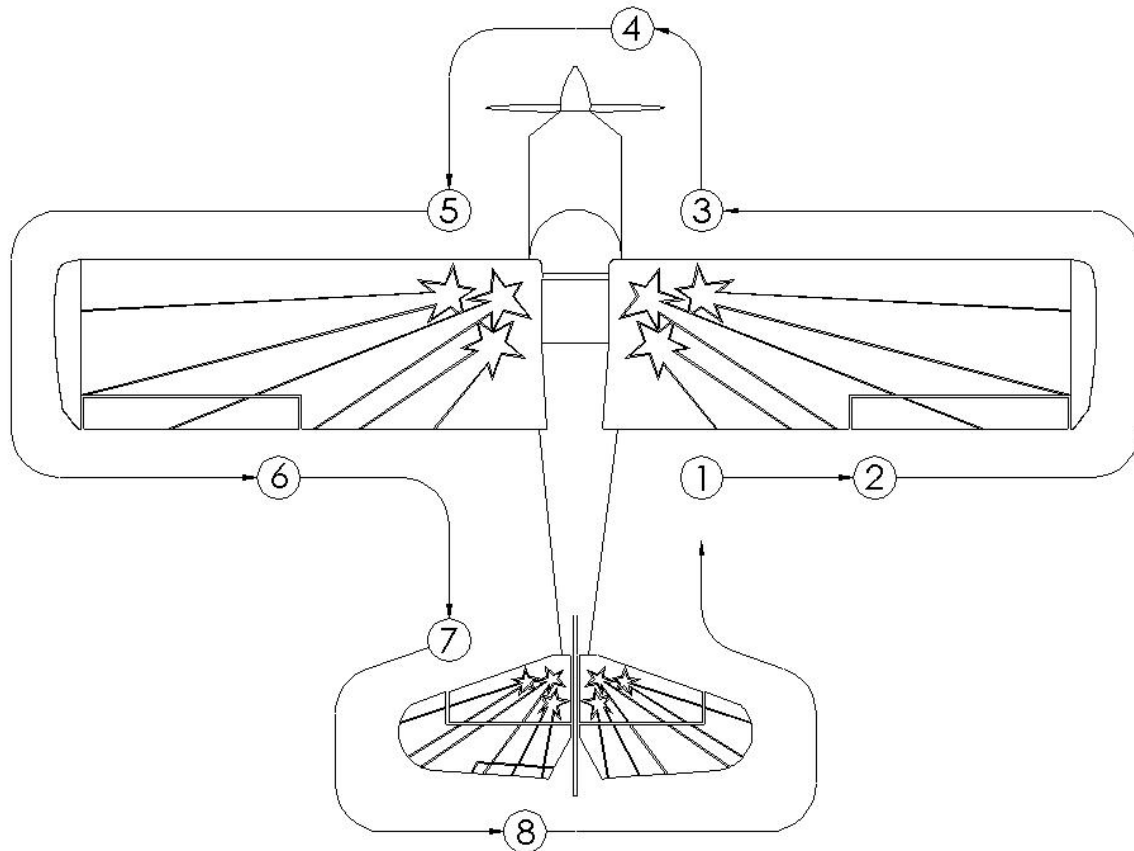

Figure 3-1, Pre-Flight Inspection (See Page 12)

### 3.2 Pre-Start Check

- 1) Seat belts - adjust and secure  
Lap belts must be taut; verify slack is not present in lap belts. Verify interference is not present between front lap belts and rear rudder pedals.
- 2) Fuel valve handle - on
- 3) Brakes - test and set
- 4) Radios and electrical equipment - off

### 3.3 Engine Start

The engine is equipped with one retard breaker magneto (left) and one standard magneto (right). Start on left magneto only.

#### CAUTION

Starting on both magnetos may result in kickback that may cause damage to the starter and or engine.

- 1) Master - on
- 2) Mixture - rich
- 3) Throttle - full
- 4) Fuel pump - on for 3 seconds
- 5) Mixture - idle cut off
- 6) Throttle - cracked
- 7) Alternate air - cold
- 8) Propeller area - clear
- 9) Ignition switch - left on
- 10) Starter button - depress, release when engine starts
- 11) Mixture - rich when engine starts
- 12) Ignition switch - right on
- 13) Oil pressure - check

#### Engine Hot Start:

- 1) Master - on
- 2) Mixture - idle cut off
- 3) Throttle - cracked
- 4) Alternate air - cold
- 5) Propeller area - clear
- 6) Ignition switch - left on
- 7) Starter button - depress, release when engine starts
- 8) Mixture - rich when engine starts
- 9) Ignition switch - right on
- 10) Oil pressure - check

#### Engine Flooded Start:

- 1) Master - on
- 2) Mixture - idle cut off
- 3) Throttle - full open
- 4) Alternate air - cold
- 5) Propeller area - clear
- 6) Ignition switch - left on
- 7) Starter button - depress, release when engine starts
- 8) Mixture - rich when engine starts
- 9) Throttle - reduce when engine starts
- 10) Ignition switch - right on
- 11) Oil pressure - check

### 3.4 Cockpit (Before Flight)

- 1) Cabin door - latched
- 2) Flight controls - check for freedom of movement and operation  
Verify lap belts are taut. Verify interference is not present between front lap belts and rear rudder pedals.
- 3) Trim tab - centered

### 3.5 Engine Run-Up

- 1) Throttle setting - 2100 rpm
- 2) Mixture - full rich or lean for altitude
- 3) Magnetos - check (150 rpm maximum drop, 50 rpm maximum differential)
- 4) Alternate air - check operation
- 5) Engine instruments - within green arc
- 6) Throttle - 1500 rpm
- 7) Propeller - cycle
- 8) Throttle - idle check

### 3.6 Takeoff (Normal)

- 1) Mixture - full rich or lean for altitude
- 2) Propeller - full forward
- 3) Fuel pump - on
- 4) Alternate air - cold
- 5) Throttle - full
- 6) Engine instruments - within green arc

### 3.7 Takeoff (Short Field)

- 1) Propeller - full forward
- 2) Fuel pump - on
- 3) Alternate air - cold
- 4) Brakes - apply
- 5) Throttle - full
- 6) Mixture - full rich or lean for altitude
- 7) Engine instruments - within green arc
- 8) Brakes - release
- 9) Rotate - 58 mph IAS
- 10) Obstacle speed - 70 mph IAS

### 3.8 Climb

- 1) Throttle - full
- 2) Mixture - full rich or lean for altitude
- 3) Propeller - full forward
- 4) Fuel pump - off
- 5) Climb speed - best rate
- 6) Engine instruments - within green arc



### 3.9 Cruise

- 1) Power - as desired
- 2) Elevator trim - adjust
- 3) Mixture - best power or best economy
- 3) Alternate air - as required
- 4) Engine instruments - within green arc

Best power can be determined by leaning the mixture until the first indication of power reduction. Enrich mixture three complete turns from the first indication of power reduction. Best power corresponds to 150°F rich of peak EGT. Use best power for cruise at or above 75% power.

Best economy can be determined by leaning the mixture until the first indication of power reduction. Enrich mixture power until smooth and engine power is restored, approximately one turn. Best economy corresponds to peak EGT. Use best economy for cruise below 75% power.

### 3.10 Landing (Normal)

- 1) Mixture - rich
- 2) Propeller - full forward
- 3) Fuel pump - on
- 4) Alternate air - hot
- 5) Airspeed - 80 mph IAS

### 3.11 Landing (Short Field)

- 1) Mixture - rich
- 2) Propeller - full forward
- 3) Fuel pump - on
- 4) Alternate air - hot
- 5) Airspeed - 76 mph IAS
- 6) Throttle - reduce to idle after obstacle
- 7) Brakes - apply

### 3.12 Balked Landing

- 1) Throttle - full
- 2) Alternate air - cold
- 3) Airspeed - 76 mph IAS

### 3.13 After Landing

- 1) Fuel pump - off
- 2) Alternate air - cold

### 3.14 Shut Down and Securing Aircraft

- 1) Parking - into the wind if possible
- 2) Park brake - set
- 3) Radios and electrical equipment - off
- 4) Magnetos - check
- 5) Mixture - idle cut-off
- 6) Ignition and master switches - off
- 7) Control lock - secure seat belt around front control stick

### 3.15 Alternate Air

Avoid using alternate air on the ground. With alternate air on, induction air is not filtered and abrasive dirt particles may enter the engine. In flight, use alternate air when icing is suspected. Turn "OFF" front and rear cabin heat to maximize alternate air temperature. Induction icing is indicated by a gradual loss of manifold pressure or engine roughness.

### 3.16 Fuel Pump

The fuel pump is used to provide fuel pressure for priming and to provide fuel pressure if the engine-driven pump fails. The fuel pump should be used during takeoff and landing and switched off during normal flight.

### 3.17 Detuning

Detuning the engine counterweight system can occur when the engine is operated outside of the normal range or by abrupt throttle movement.

#### CAUTION

Detuning results in rapid and severe damage to the counterweights, rollers, and bushings culminating in engine failure.

Avoid rapid throttle movement - give special consideration to high power settings; i.e. ground run up or in-flight power reduction.

Avoid high rpm and low manifold pressure - Avoid power-off descent below 15 in-Hg of manifold pressure. During approach do not select low pitch (high rpm) until it is assured that there will be no increase in engine rpm; i.e. idle power below 100 mph IAS.

### 3.18 Acrobatic Operation

Maneuvers limits are listed in Section 1.8. Determine that all loose objects, including unused seatbelts, are removed from the aircraft or secured to prevent movement in flight.

Full movement of the ailerons may be used at speeds up to  $V_A$  provided the load factor does not exceed +4.0 or -3.2 g. Use of ailerons above  $V_A$  should be smooth and limited to deflections that do not exceed the rate of roll at  $V_A$ .

#### CAUTION

Full abrupt use of the ailerons combined with full abrupt use of the elevator at  $V_A$  may produce loads in excess of design limits.

### **3.18 Acrobatic Operation (Continued)**

A propeller setting of 2500 rpm is recommended for all maneuvers.

### **3.19 Spins**

Acrobatic Category spins are approved. Loss of altitude including recovery from a six-turn spin may be as much as 3000 ft.

#### **WARNING**

Free release of the controls is not adequate for spin recovery; positive movement of the controls is required.

To enter a spin:

- 1) Throttle - reduce to idle
- 2) Airspeed - decelerate to stall
- 3) Rudder - apply in direction of spin
- 4) Elevator - apply fully to stall aircraft

To recover from a spin:

- 1) Throttle - idle
- 2) Neutralize ailerons
- 3) Apply full rudder opposite of rotation
- 4) Apply neutral elevator
- 5) When rotation stops neutralize rudder, apply elevator smoothly to raise nose

### **3.20 Maximum Demonstrated Crosswind**

Maximum demonstrated crosswind velocity for takeoff and landing is 20 mph (17 knots).

### **3.21 Turbulence Penetration Speed**

Do not exceed 110 mph IAS in rough air to prevent overstressing the aircraft. To minimize personal discomfort, decrease airspeed to 100 mph IAS. Maintain a constant pitch rather than flying by reference to the altimeter and airspeed indicators.

### **3.22 Noise Characteristics**

The noise level measured in accordance with FAR 36, Appendix G and ICAO Annex 16, Vol. 1, Cap. 10 is 80.90 dBA.

No determination has been made by the Federal Aviation Administration that the noise levels of this airplane are or should be acceptable or unacceptable for operation at, into, or out of, any airport.

## 4.0 Performance Information

### 4.1 Airspeed Calibration

IAS (mph)	CAS (mph)
58	58
60	60
80	80
100	100
120	120
140	139
160	158
180	176
200	194
207	200

- 1) Assumes zero instrument error
- 2) Power required for level flight

### 4.2 Stalling Speeds

IAS (mph) - Angle of Bank			
0°	30°	45°	60°
58	62	69	82

- 1) Gross weight - 1950 lb

### 4.3 Best Glide Speed and Distance

Height AGL (ft)	Distance (nm)
2000	2.3
4000	4.6
6000	6.9
8000	9.1
10000	11.4

- 1) Best glide airspeeds IAS (mph), 1950 lb - 70, 1800lb - 68, 1650lb - 65
- 2) Best glide range and airspeeds are substantially affected by headwind, tailwind, updrafts and downdrafts, chart is for still-air only

#### 4.4 Climb Rate and Gradients

Best Rate of Climb Speed Sea Level: 81 mph IAS, 81 mph CAS  
 Best Rate of Climb Speed Decreases 0.6 mph per 1000 ft Gain in Density Altitude  
 Best Rate of Climb is 1498 fpm Decreasing 71 fpm per 1000 ft Gain in Density Altitude

Best Angle of Climb Speed Sea Level: 57 mph IAS, 57 mph CAS  
 Best Angle of Climb Speed Increases 0.2 mph per 1000 ft Gain in Density Altitude  
 Sea Level Best Climb Gradient is 25.6% Decreasing 1.2% per 1000ft Gain in Density Altitude

Service Ceiling is 20000 ft

#### 4.5 Takeoff Distance

Conditions:

1. Gross Weight - 1950 lb
2. Speed at Lift Off - 58 mph IAS
3. Speed at 50 Feet - 70 mph IAS
4. Level, Hard Surface, Dry Runway
5. Zero Wind

Pressure Altitude	Distance (ft)									
	0° C (32° F)		10° C (50° F)		20° C (68° F)		30° C (86° F)		40° C (104° F)	
	Ground Roll	Total 50 ft	Ground Roll	Total 50 ft	Ground Roll	Total 50 ft	Ground Roll	Total 50 ft	Ground Roll	Total 50 ft
0	468	861	502	925	539	992	576	1060	615	1132
2000	538	960	578	1032	620	1106	663	1182	707	1262
4000	642	1096	690	1178	740	1262	791	1350	844	1441
6000	714	1204	767	1293	822	1386	879	1482	938	1582
8000	891	1421	957	1527	1026	1636	1097	1750	1171	1867
10000	1050	1626	1128	1747	1209	1872	1293	2002	1380	2136

1. Data presented in this table represents maximum airplane capability at speeds shown and requires aircraft in good operating condition and a proficient pilot
2. Decrease distances 12% for every 10 mph of headwind
3. Downwind takeoff is not recommended, increase distances 12% for every 2 mph of tailwind
4. Increase distances 12% of the ground roll for grass or gravel surfaces

#### 4.6 Time, Fuel, and Distance to Climb

Conditions:

1. Gross Weight - 1950 lb
2. Mixture - Full Rich, Lean for Smooth Operation
3. Standard Temperature

From Sea Level						
Pressure Altitude (ft)	Temperature (° C)	Climb Speed IAS (mph)	Rate of Climb (fpm)	Time (min)	Fuel (gal)	Distance (nm)
0	15	81	1498	0	1.0	0
3000	9	79	1285	2	1.6	2
6000	3	77	1073	5	2.2	5
9000	-3	75	860	8	2.9	9
12000	-9	73	647	12	3.7	13
15000	-15	71	434	17	4.5	19
18000	-21	69	222	26	5.7	28

1. Data presented in this table represents maximum airplane capability at speeds shown and requires aircraft in good operating condition and a proficient pilot
2. Distances shown are based on zero wind
3. Allow one gallon fuel for engine start, taxi and takeoff
4. Decrease distance for head wind or increase distance for tail wind with the following increment:  $\text{Time (min)} / 60 \times \text{wind component in the direction of flight (knots)}$

### 4.7 Cruise Performance

Conditions:

1. Gross Weight - 1950 lb
2. Recommended Lean Mixture
3. Standard Temperature and Pressure

% BHP	RPM	MP	TAS (mph)	GPH
3000 ft				
94	2700	26.4	159	15.7
83		24.0	148	13.7
74		22.0	139	9.4
65		20.0	129	8.3
89	2550	26.5	155	14.6
78		24.0	144	12.6
70		22.0	135	8.8
61		20.0	126	7.9
85	2450	26.5	151	13.9
75		24.0	141	12.0
67		22.0	132	8.5
58		20.0	123	7.5
81	2350	26.6	146	13.1
71		24.0	136	9.0
63		22.0	128	8.1
55		20.0	120	7.2
9000 ft				
76	2700	21.0	154	12.3
71		20.0	149	9.0
61		18.0	138	8.0
52		16.0	128	7.0
71	2550	21.1	150	9.0
67		20.0	145	8.5
58		18.0	135	7.5
49		16.0	124	6.5
69	2450	21.2	148	8.6
64		20.0	142	8.2
55		18.0	133	7.2
46		16.0	122	6.2
65	2350	21.3	143	8.3
60		20.0	138	7.8
52		18.0	130	6.9
45		16.0	121	6.1

% BHP	RPM	MP	TAS (mph)	GPH
6000 ft				
83	2700	23.6	155	13.7
78		22.0	149	12.6
68		20.0	139	8.7
59		18.0	129	7.6
80	2550	23.7	153	13.0
73		22.0	145	9.2
64		20.0	135	8.2
55		18.0	125	7.2
77	2450	23.8	150	12.4
70		22.0	142	8.8
61		20.0	132	7.9
52		18.0	123	6.9
73	2350	23.9	145	11.7
66		22.0	137	8.4
58		20.0	129	7.5
50		18.0	121	6.6
12000 ft				
67	2700	18.6	152	8.6
64		18.0	149	8.3
55		16.0	138	7.2
65	2550	18.7	150	8.3
61		18.0	145	7.9
51		16.0	133	6.8
62	2450	18.8	147	8.0
58		18.0	143	7.5
49		16.0	132	6.5
59	2350	18.9	144	7.6
55		18.0	139	7.2
48		16.0	131	6.4

### 4.8 Landing Distance

Conditions:

1. Gross Weight - 1950 lb
2. Approach Speed - 76 mph IAS
3. Maximum braking
4. Level, Hard Surface, Dry Runway
5. Zero Wind

A high rate of descent is possible in this configuration. If airspeed is allowed to decrease below 76 mph IAS, landing flare can only be assured with an application of power.

Pressure Altitude	Distance (ft)									
	0° C (32° F)		10° C (50° F)		20° C (68° F)		30° C (86° F)		40° C (104° F)	
	Ground Roll	Total 50 ft.	Ground Roll	Total 50 ft.	Ground Roll	Total 50 ft.	Ground Roll	Total 50 ft.	Ground Roll	Total 50 ft.
0	722	1264	776	1318	832	1373	889	1431	949	1491
2000	821	1363	883	1424	946	1488	1012	1553	1080	1621
4000	943	1485	1013	1555	1086	1628	1161	1703	1239	1781
6000	1093	1635	1175	1717	1259	1801	1346	1888	1437	1978
8000	1283	1825	1378	1920	1477	2019	1580	2122	1686	2228
10000	1526	2068	1640	2182	1758	2300	1880	2421	2006	2547

1. Data presented in this table represents maximum airplane capability at speeds shown and requires aircraft in good operating condition and a proficient pilot
2. Decrease the distances shown by 10% for every 10 mph of headwind
3. Downwind landing is not recommended, increase distances 11% for every 2 mph of tailwind
4. Increase distances 36% of the ground roll for grass or gravel surfaces



## **5.0 Loading Information**

Weight and balance data is prepared individually for each airplane. The FAA has approved the procedures used in this section.

This section provides a weight and balance report, moment and loading envelope, and equipment list. These items are explained below.

### **5.1 Weight and Balance**

The weight and balance report gives the official aircraft empty weight, empty moment, empty CG, and useful load. The empty weight includes unusable fuel and undrainable oil.

### **5.2 Moment and Loading**

The loading envelope shows the allowable limits of the total airplane moment from the minimum weight to the gross weight. The moment diagram gives the moment contribution of the pilot, passenger, fuel, oil, and baggage. To find the moment contribution of a 100lb passenger, move vertically upward along the weight scale to 100lb, move horizontally to the passenger line, the moment contribution is read vertically downward from this point, i.e. 4500 in-lbs.

To determine if a particular weight configuration is acceptable, find the total weight and the total moment by summing the contributions of each component, including the empty airplane (oil moment is negative and must be subtracted). On the loading diagram, locate the intersection of the total weight and total moment. If the intersection lies within the envelope, the configuration is acceptable.

### **5.3 Equipment**

Each item installed on the airplane at the time of weighting is marked with an X on the equipment list. The weight and moment of each item are also shown.



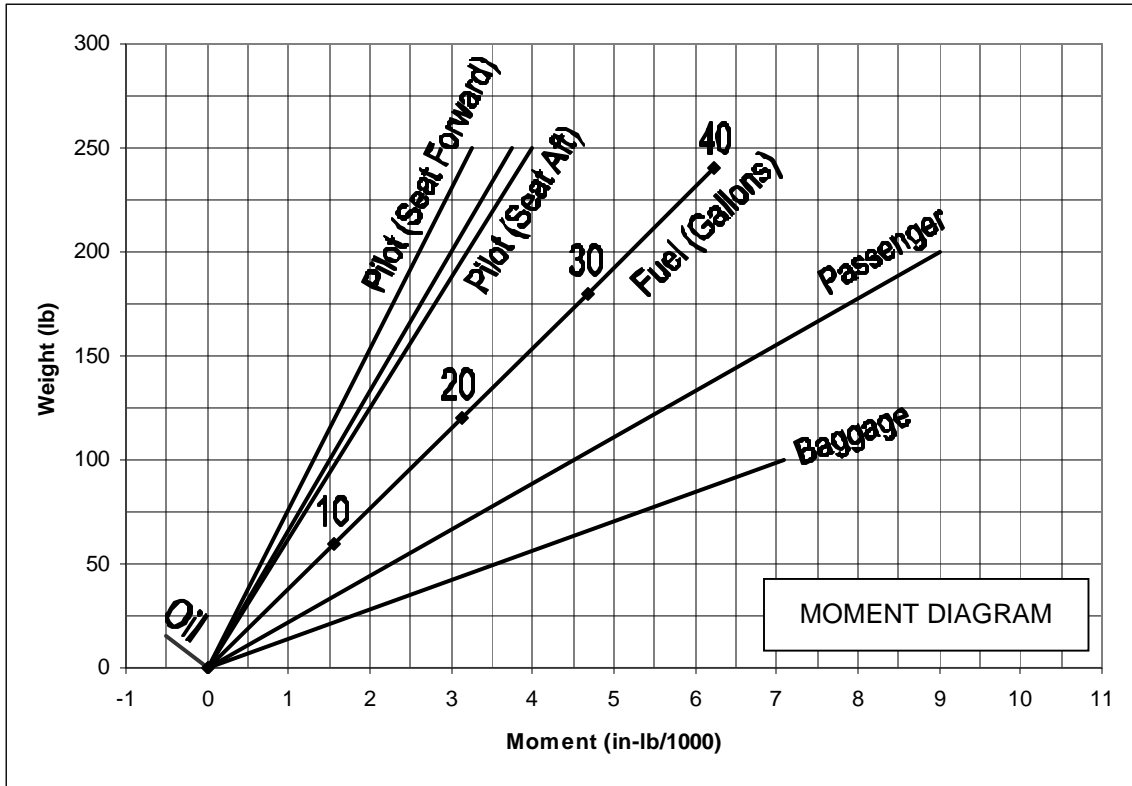

Add weights and moment of items in MOMENT DIAGRAM to airplane empty weight and moment (negative oil moment). Locate intersection of total weight and moment on AIRPLANE LOADING ENVELOPE. Any point falling within the envelope meets all balance requirements.

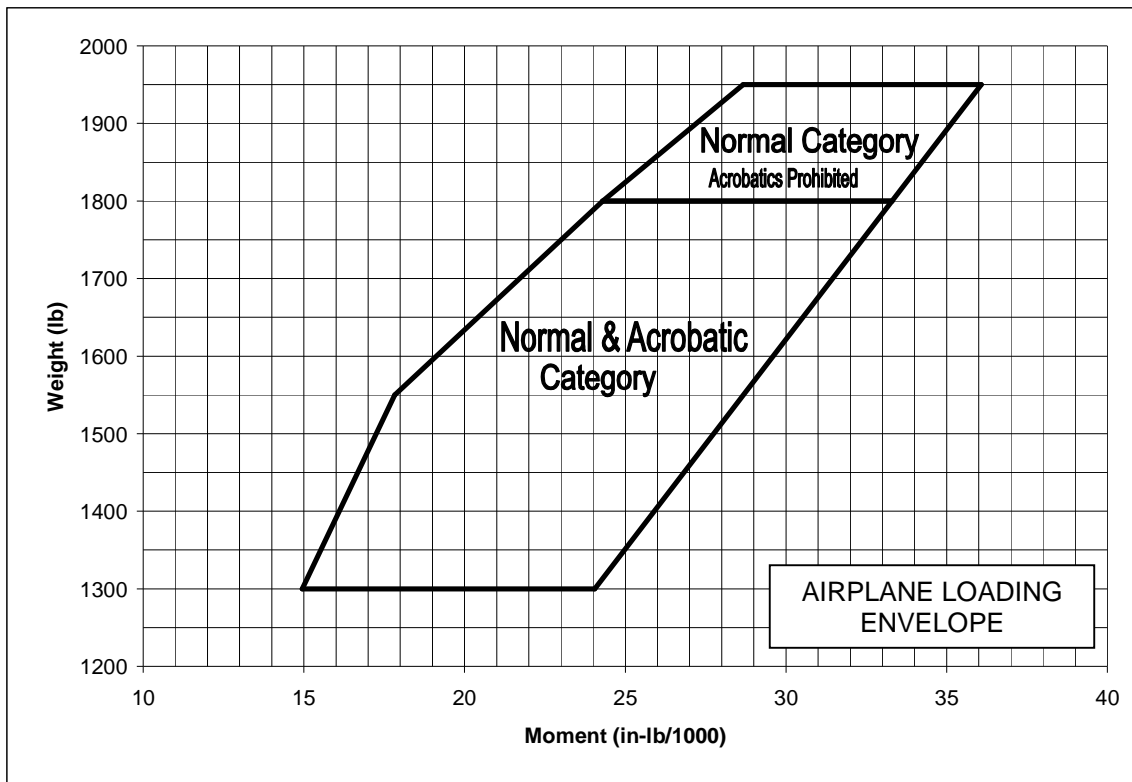

## 5.4 Equipment List

Suffix Letters on Item Numbers:

R: Required for Certification

S: Standard Equipment

A: Optional Equipment Not Required

O: Optional Equipment Replacing Standard or Required Item

ITEM NO.	X	DESCRIPTION	DRAWING	WT, LB	ARM, IN
1R	X	Engine, Lycoming AEIO-390-A1B6	7-1617	331.00	-38.78
2R	X	Propeller and Spinner, MTV-15-B-C/C193-25	4-2010	52.00	-58.91
3R	X	4345 Magneto - Retard Breaker (left)	7-1617	4.10	-27.63
4R	X	4370 Magneto - Standard (right)	7-1617	4.10	-26.81
5R	X	Starter - Skytec	7-1617	8.10	-47.97
6R	X	Alternator - Plane Power	7-1617	9.80	-47.50
7R	X	Propeller Governor	7-2010	2.20	-48.38
8R	X	Fuel Pump - Electric	7-1617	3.20	-23.28
9R	X	Filter - Induction Air	7-1617	0.80	-50.25
10R	X	Oil Cooler - Left	7-1617	1.80	-27.25
11R	X	Oil Cooler - Right	7-1617	1.80	-30.50
12R	X	Oil Filter and Adapter	7-1617	2.90	-25.44
13R		Tachometer	7-1524	0.80	-3.00
14R		Manifold and Fuel Pressure - Combination	7-1524	1.20	-3.00
15R		Oil Temperature	7-1524	0.30	-3.00
16R		Oil Pressure	7-1524	0.30	-3.00
17R		Ammeter	7-1524	0.30	-3.00
18O		Engine Display - EDM-930	7-1580	3.00	-3.00
19O		Fuel and Manifold Pressure - FM200	7-1524	0.30	-3.00
20O		Tachometer - R-1	3-1730	0.40	-3.00
21O		Manifold Pressure - M-1	3-1730	0.60	-3.00

ITEM NO.	X	DESCRIPTION	DWG	WT, LB	ARM, IN
22O		Oil Pressure / Oil Temperature - OPT-1	3-1730	1.00	-3.00
23O		Ammeter - VA-1A	3-1730	0.60	-3.00
24O		Fuel Flow / Fuel Pressure - FP-5L	3-1730	1.00	-3.00
25A		Engine Analyzer - EAC-1, SR-8A, US-8A, UBG-16	3-1730	1.00	-3.00
26R	X	Altimeter	7-1524	0.80	-3.00
27R	X	Airspeed Indicator	7-1524	0.60	-3.00
28R		Compass - Airpath	4-1736	0.80	-4.00
29O		Compass - Vertical Card	4-1736	0.80	-4.00
30A		Electronic Flight Display - EFD1000	7-1611	2.90	-3.00
31A		Vertical Speed Indicator	7-1524	0.70	-3.00
32A		Turn Coordinator - Electric	7-1524	1.20	-3.00
33A		Artificial Horizon - Electric	7-1524	2.10	-3.00
34A		Directional Gyro - Electric	7-1524	2.50	-3.00
35A		Artificial Horizon - Vacuum	7-1524	2.80	-3.00
36A		Directional Gyro - Vacuum	7-1524	2.80	-3.00
37A		Vacuum Pump	7-1125	1.80	-26.38
38A		Suction Gauge	7-1125	0.10	-3.00
39R	X	Accelerometer	7-1524	0.50	-3.00
40A		Outside Air Temperature	7-1415	0.30	3.00
41A		Clock	7-1524	0.30	-3.00
42A		Hobbs Meter	7-1524	0.30	-3.00
43R	X	Rear Battery Installation - Concorde	4-1782	27.50	88.00
44O		Rear Battery Installation - Enersys	4-1782	19.40	87.00
45R	X	Voltage Regulator	4-2148	0.50	-21.34
46R	X	Stall Warning	4-1401	0.90	0.25

ITEM NO.	X	DESCRIPTION	DWG	WT, LB	ARM, IN
47O		Heated Pitot	2-2256	0.80	41.44
48R	X	Navigation, Strobe and Position Lights - Wing	4-2137	0.50	17.63
49R	X	Landing Light - Cowling	4-2127	0.50	-50.38
50S	X	Cabin Light	7-1524	0.60	24.00
51A		Auxiliary Power Plug	4-2043	0.30	-1.00
52R	X	Aluminum Gear Legs - P/N 4-2139	7-1559	28.88	2.63
53R	X	Wheels and Brakes - Cleveland 20-16D	7-1559	13.94	2.44
54S	X	Tires and Tubes - 6.00 x 6, Type III, 4 Ply	7-1559	15.00	1.75
55A		Wheel Pants	4-1474	10.00	2.00
56R	X	Tailwheel	4-1080	7.80	193.50
57R	X	Seat and Belt Installation - Front Adjustable	7-1499	15.60	17.38
58R		Seat and Belt Installation - Rear	4-1708	13.60	47.75
59O		Seat and Belt Installation - Wide Rear	4-1709	18.40	47.75
60O		Hooker Harness Front - Sport Belt	3-1660	2.50	19.50
61O		Hooker Harness Rear - Sport Belt	3-1660	2.50	49.88
62O		Hooker Harness Front - Competition Belt	3-1660	2.50	19.50
63O		Hooker Harness Rear - Competition Belt	3-1660	2.50	49.88
64S	X	Greenhouse	7-1268	6.00	26.00
65A		Rear Baggage Door	3-1717	5.50	72.41
66A		Rear Seat Heat	7-1478	2.30	-7.00
67S	X	Microphone	7-1524	0.40	12.00
68A		Cabin Speaker	3-1682	1.40	38.00
69R	X	Emergency Locator Transmitter	3-1689	3.00	65.75
70A		Fire Extinguisher	7-1415	2.30	11.63
71R	X	Cargo Net	7-1415	1.00	62.25

ITEM NO.	X	DESCRIPTION	DWG	WT, LB	ARM, IN
72A		Glider Tow	7-1143	4.00	147.00
73A		Speed Fairings	4-2025	1.00	12.00
74A		Corrosion Proofing	CFP-2	5.00	92.00
75A		Antenna, Broad Band, COM 1	4-2072	0.50	66.00
76A		Antenna, Broad Band, COM 2	4-1631	0.50	94.00
77A		Antenna, NAV	3-1542	0.50	167.00
78A		Antenna, GPS	3-1751	0.50	7.50
79A		Antenna, Marker Beacon	4-2079	0.60	-1.00
80A		Antenna, Transponder	3-1752	0.10	-18.75
81A		Encoder - Sandia	4-2036	0.70	-11.63
82A		Intercom	4-2036	1.00	-3.00
83A		Garmin GI 106A Course Deviation Indicator	4-2036	1.40	-3.00
84A		Garmin GMA 340 Audio Panel	4-2036	1.70	-3.00
85A		Garmin SL40 COM	4-2036	2.00	-3.00
86A		Garmin SL30 NAV COM	4-2036	3.30	-3.00
87A		Garmin GTX 327 Transponder	4-2036	3.10	-3.00
88A		Garmin GTX 328 Transponder	4-2036	4.20	-3.00
89A		Garmin GTX 330 Transponder	4-2036	4.20	-3.00
90					
91					
92					
93					
94					
95					
96					